

RT3U11M

Composite Transistor
For high speed switching
Silicon N-channel+P-channel MOSFET

DESCRIPTION

RT3U11M is a composite transistor built with INK0001AX and INJ0001AX chips in SC-88 package.

FEATURE

- Input impedance is high, and not necessary to consider a drive electric current.
- Drive voltage 2.5V
- Low on Resistance. $R_{ON}=3.5 / 7\Omega$ (Tr1/Tr2) (TYP)
- High speed switching.
- Small package for easy mounting.

APPLICATION

High speed switching , Analog switching

*P-channel MOSFET Tr2's minus sign is omitted

OUTLINE DRAWING

Unit: mm

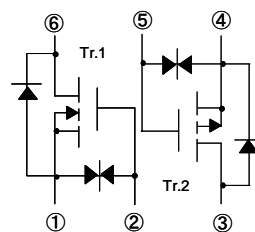
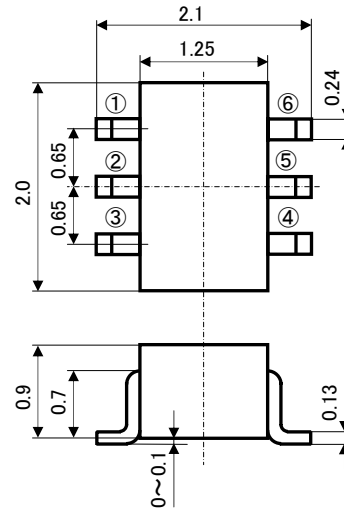

TERMINAL CONNECTOR

- ①: SOURCE1
- ②: GATE1
- ③: DRAIN2
- ④: SOURCE2
- ⑤: GATE2
- ⑥: DRAIN1

JEITA: SC-88

MAXIMUM RATING (Ta=25°C) (Tr1,Tr2 Common)

SYMBOL	PARAMETER	RATING	UNIT
VDSS	Drain-source voltage	50	V
VGSS	Gate-source voltage	±8	V
ID	Drain current(DC)	100	mA
IDP	Drain current(Pulse)	400(※1)	mA
PD	Total power dissipation	150	mW
Tch	Channel temperature	+150	°C
Tstg	Range of Storage temperature	-55~+150	°C

※1: $P_w \leq 10\mu s$, Duty cycle $\leq 1\%$

MARKING

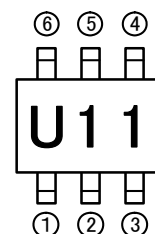

RT3U11M

Composite Transistor
For high speed switching
Silicon N-channel+P-channel MOSFET

Tr1 ELECTRICAL CHARACTERISTICS (Ta=25°C)

SYMBOL	Parameter	Test conditions	Limits			Unit
			Min	Typ	Max	
V(BR)DSS	Drain-source breakdown voltage	ID=100μA, VGS=0V	50	-	-	V
IGSS	Gate-source leak current	VGS=±5V, VDS=0V	-	-	±0.5	μA
IDSS	Zero gate voltage drain current	VDS=50V, VGS=0V	-	-	1.0	μA
Vth	Gate threshold voltage	ID=250μA, VDS=VGS	0.6	-	1.2	V
Yfs	Forward transfer admittance	VDS=10V, ID=0.1A	-	250	-	mS
RDS(ON)	Static drain-source on-state resistance	ID=100mA, VGS=4.0V	-	3.5	-	Ω
Ciss	Input capacitance	VDS=10V, VGS=0V, f=1MHz	-	24	-	pF
Coss	Output capacitance		-	5	-	
ton	Switching time	VDD=5V, ID=10mA VGS=0~5V	-	11	-	ns
toff			-	50	-	

Tr2 ELECTRICAL CHARACTERISTICS (Ta=25°C)

SYMBOL	Parameter	Test conditions	Limits			Unit
			Min	Typ	Max	
V(BR)DSS	Drain-source breakdown voltage	ID=-100μA, VGS=0V	-50	-	-	V
IGSS	Gate-source leak current	VGS=±5V, VDS=0V	-	-	±0.5	μA
IDSS	Zero gate voltage drain current	VDS=-50V, VGS=0V	-	-	-1.0	μA
Vth	Gate threshold voltage	ID=-250μA, VDS=VGS	-0.6	-	-1.2	V
Yfs	Forward transfer admittance	VDS=-10V, ID=-0.1A	-	220	-	mS
RDS(ON)	Static drain-source on-state resistance	ID=-100mA, VGS=-4.0V	-	7.0	-	Ω
Ciss	Input capacitance	VDS=-10V, VGS=0V, f=1MHz	-	28	-	pF
Coss	Output capacitance		-	5.2	-	
ton	Switching time	VDD=-5V, ID=-10mA VGS=0~-5V	-	13	-	ns
toff			-	135	-	

RT3U11M

Composite Transistor
For high speed switching
Silicon N-channel+P-channel MOSFET

Tr1 TYPICAL CHARACTERISTICS

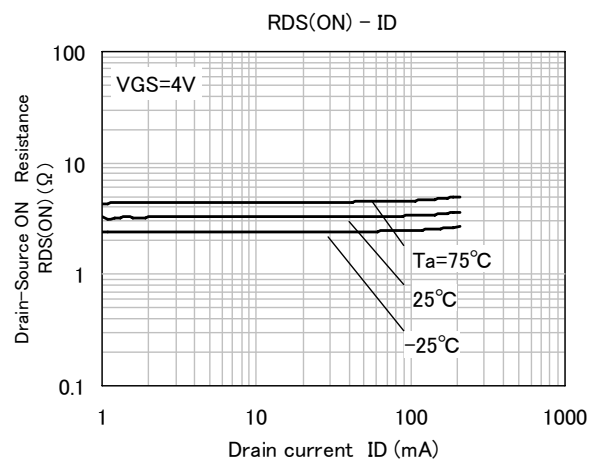
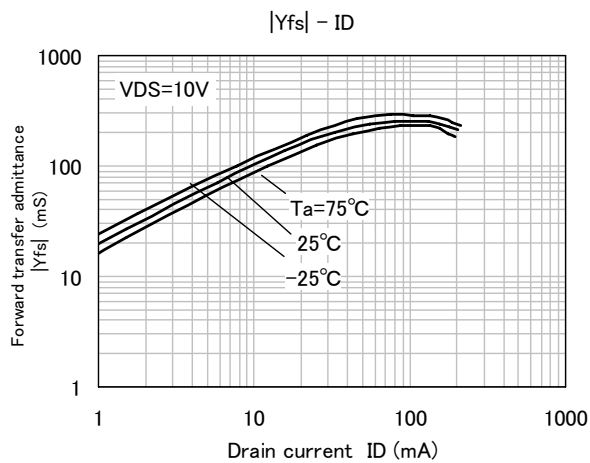
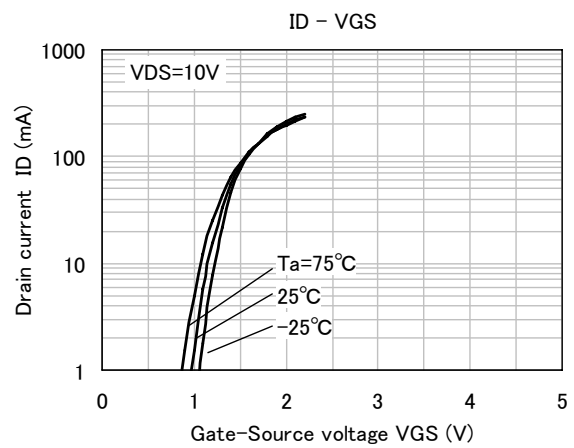
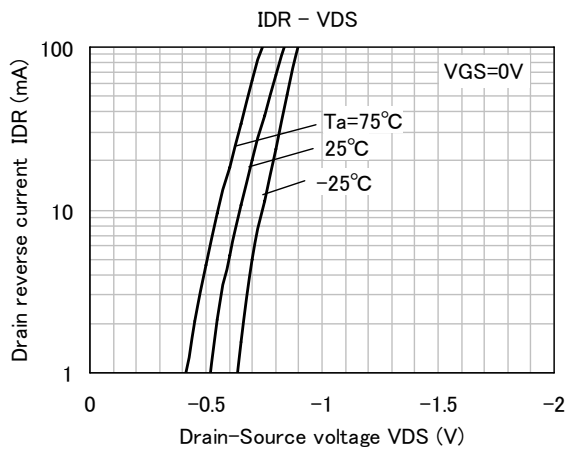
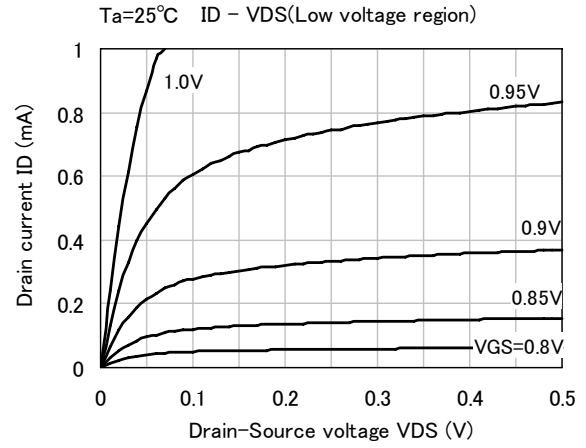
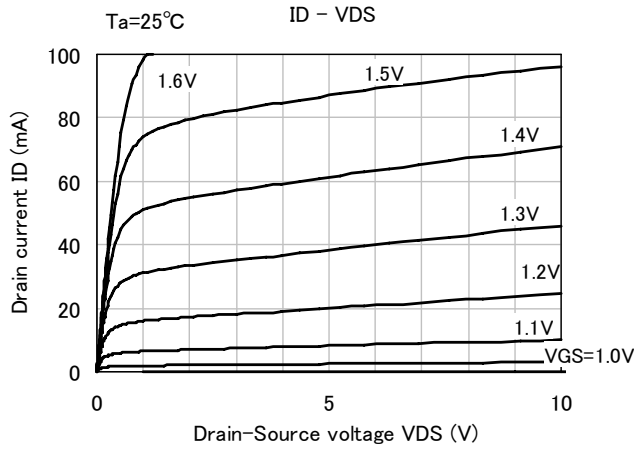

RT3U11M

Composite Transistor
For high speed switching
Silicon N-channel+P-channel MOSFET

Tr1 TYPICAL CHARACTERISTICS

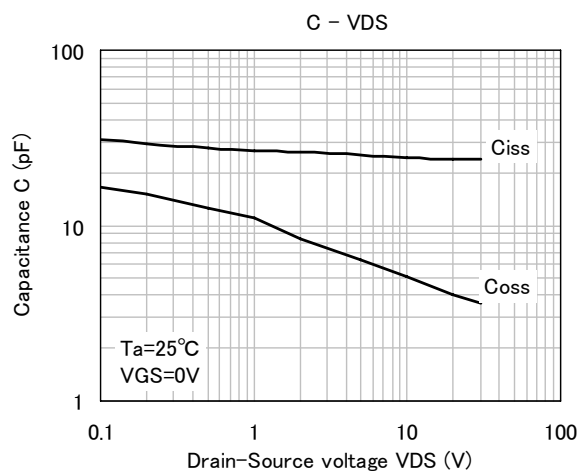
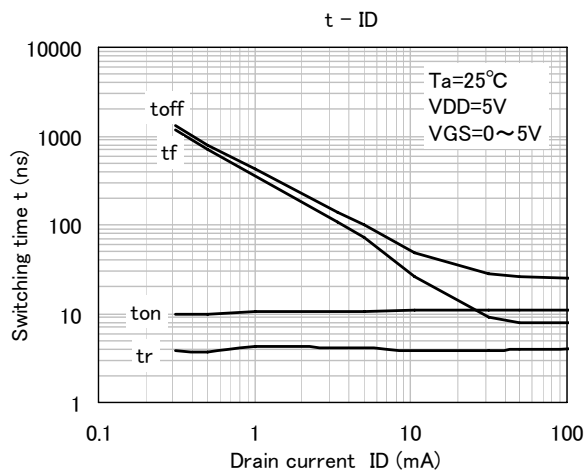
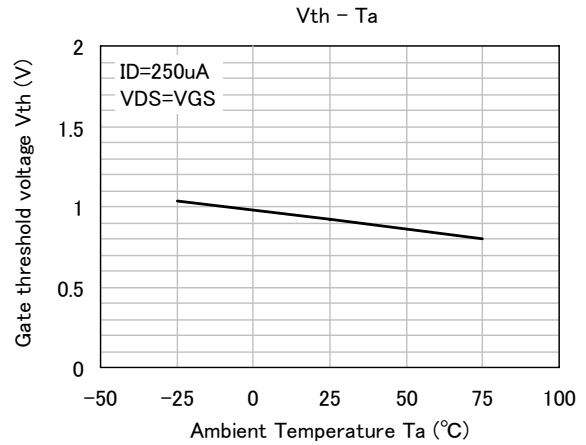
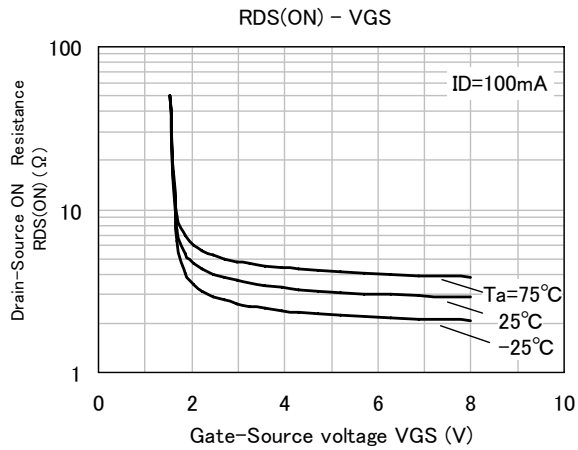

Tr1 Switching time test condition

Test circuit

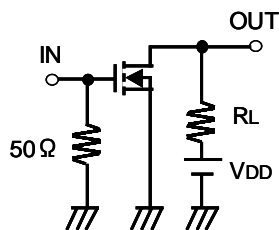
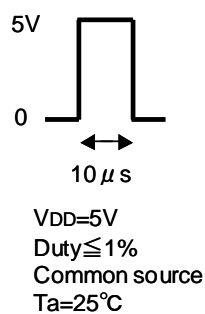

Input Waveform

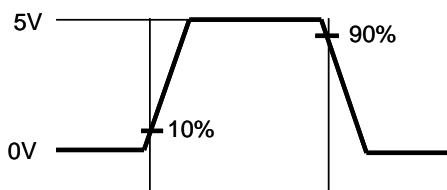

Output Waveform

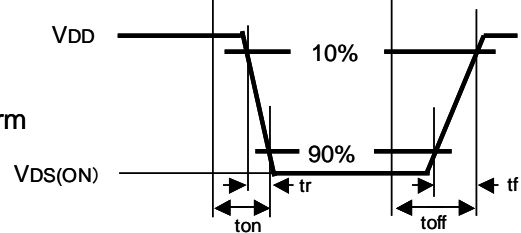

RT3U11M

Composite Transistor
For high speed switching
Silicon N-channel+P-channel MOSFET

Tr2 TYPICAL CHARACTERISTICS

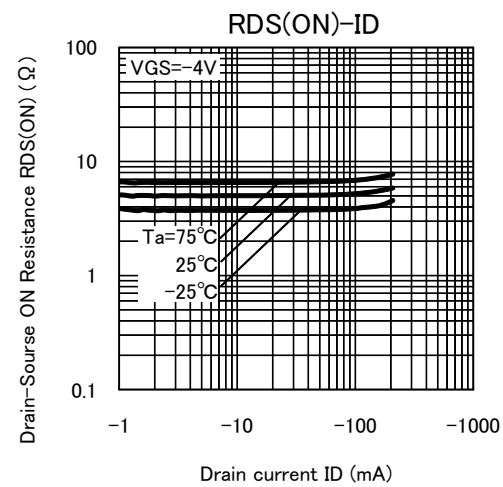
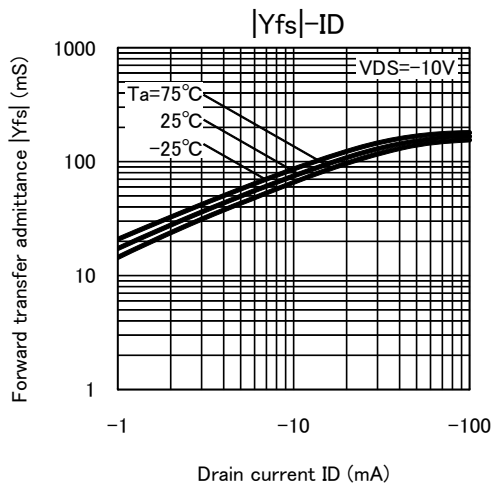
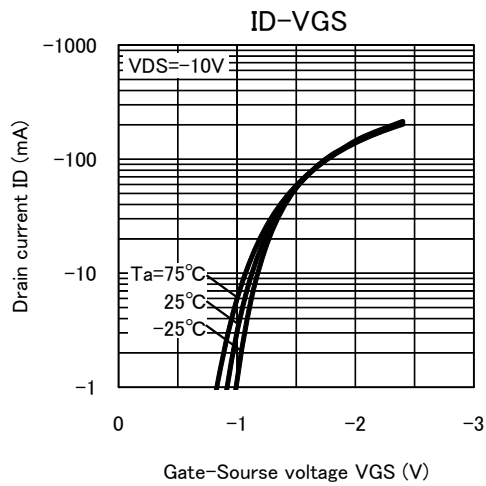
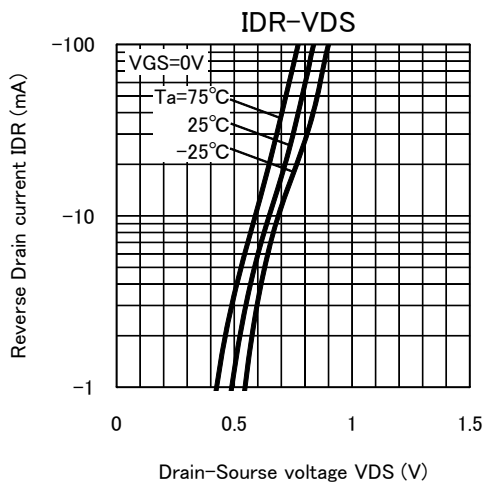
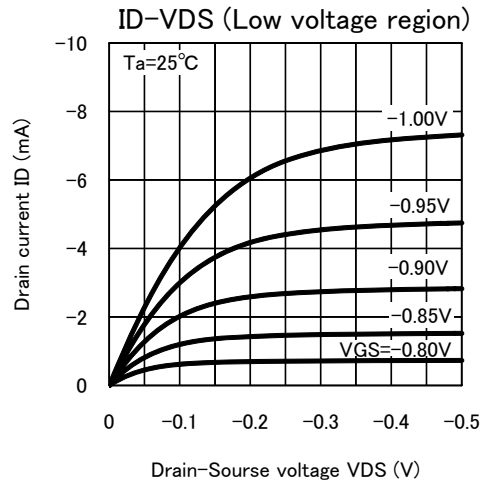
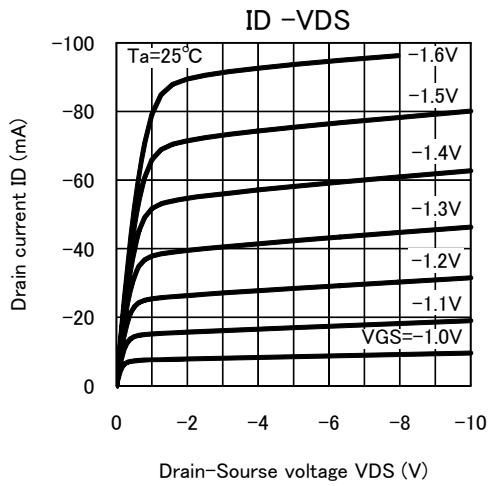

RT3U11M

Composite Transistor
For high speed switching
Silicon N-channel+P-channel MOSFET

Tr2 TYPICAL CHARACTERISTICS

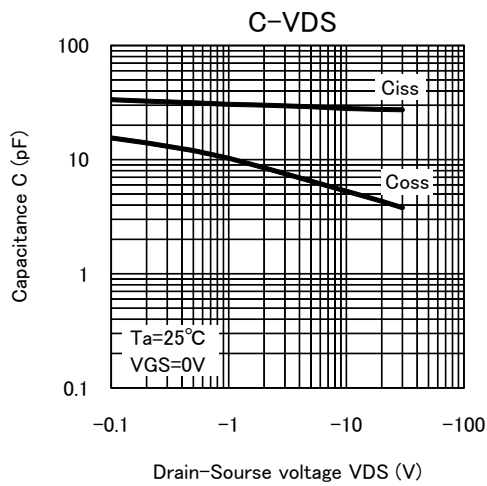
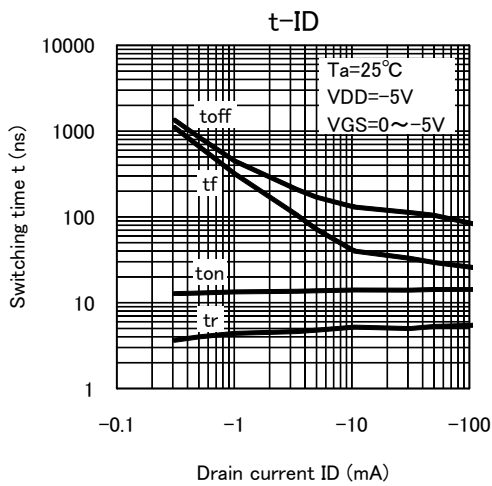
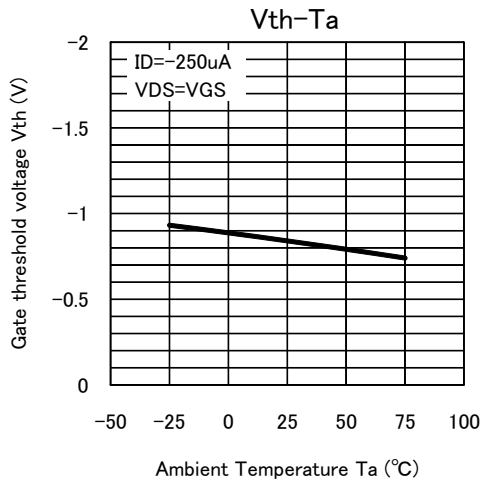
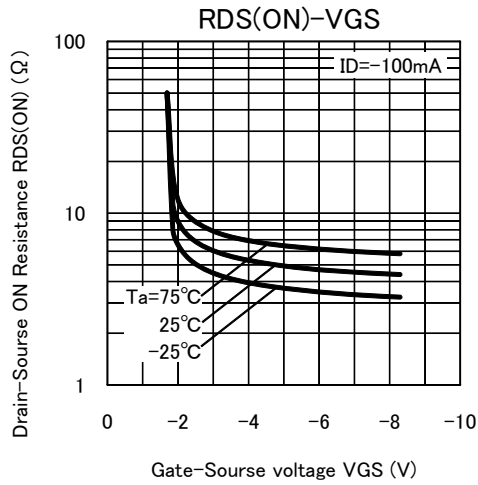

Tr2 Switching time test condition

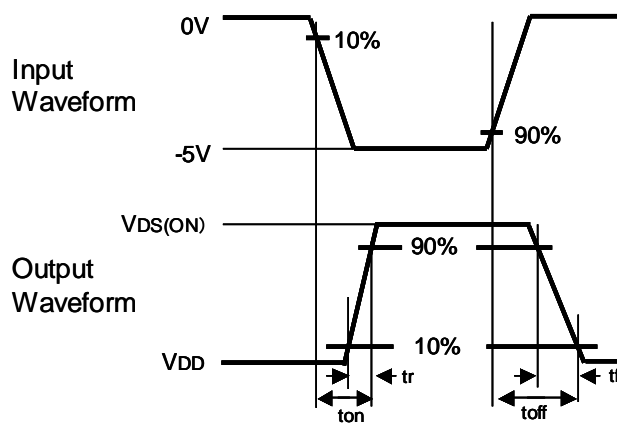
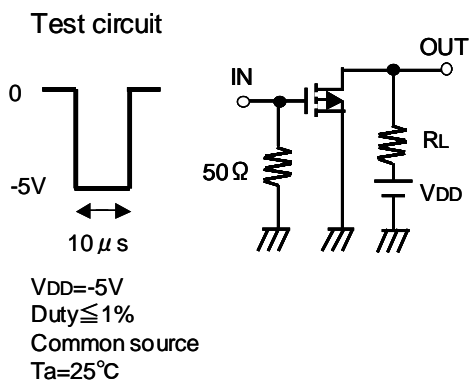



Keep safety first in your circuit designs!

·ISAHAYA Electronics Corporation puts the maximum effort into making semiconductor products better and more reliable, but there is always the possibility that trouble may occur with them. Trouble with semiconductors may lead to personal injury, fire or property damage. Remember to give due consideration to safety when making your circuit designs, with appropriate measures such as (1) placement of substitutive, auxiliary, (2) use of non-flammable material or (3) prevention against any malfunction or mishap.

Notes regarding these materials

- These materials are intended as a reference to our customers in the selection of the ISAHAYA products best suited to the customer's application; they don't convey any license under any intellectual property rights, or any other rights, belonging ISAHAYA or third party.
- ISAHAYA Electronics Corporation assumes no responsibility for any damage, or infringement of any third party's rights, originating in the use of any product data, diagrams, charts or circuit application examples contained in these materials.
- All information contained in these materials, including product data, diagrams and charts, represent information on products at the time of publication of these materials, and are subject to change by ISAHAYA Electronics Corporation without notice due to product improvements or other reasons. It is therefore recommended that customers contact ISAHAYA Electronics Corporation or an authorized ISAHAYA products distributor for the latest product information before purchasing product listed herein.
- ISAHAYA Electronics Corporation products are not designed or manufactured for use in a device or system that is used under circumstances in which human life is potentially at stake. Please contact ISAHAYA Electronics Corporation or an authorized ISAHAYA products distributor when considering the use of a product contained herein for any specific purposes, such as apparatus or systems for transportation, vehicular, medical, aerospace, nuclear, or undersea repeater use.
- The prior written approval of ISAHAYA Electronics Corporation is necessary to reprint or reproduce in whole or in part these materials.
- If these products or technologies are subject to the Japanese export control restrictions, they must be exported under a license from the Japanese government and cannot be imported into a country other than the approved destination. Any diversion or re-export contrary to the export control laws and regulations of Japan and/or the country of destination is prohibited.
- Please contact ISAHAYA Electronics Corporation or authorized ISAHAYA products distributor for further details on these materials or the products contained therein.