

RT2N05M

Composite Transistor With Resistor
For Switching Application
Silicon NPN Epitaxial Type

DESCRIPTION

RT2N05M is composite transistor with built-in bias resistor.

FEATURE

Built-in bias resistor ($R_1=47k\Omega$, $R_2=47k\Omega$)
Mini package for easy mounting

APPLICATION

Inverted circuit, Switching circuit,
Interface circuit, Driver circuit

OUTLINE DRAWING

Unit: mm

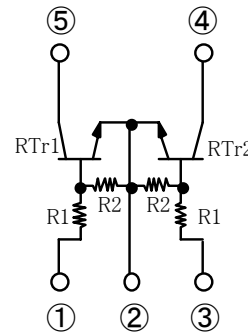
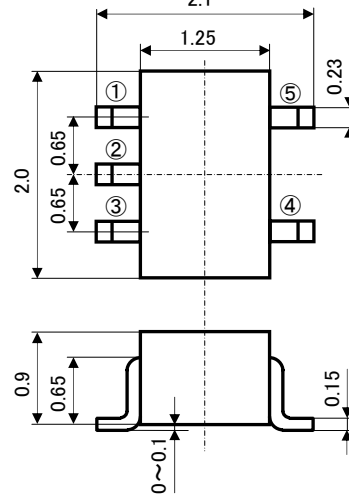

TERMINAL CONNECTOR
①: BASE1
②: EMITTER(COMMON)
③: BASE2
④: COLLECTOR2
⑤: COLLECTOR1

JEITA: SC-88A
JEDEC: -

MAXIMUM RATING($T_a=25^\circ\text{C}$)(RTr1, RTr2 COMMON)

SYMBOL	PARAMETER	RATING	UNIT
V_{CBO}	Collector to Base voltage	50	V
V_{EBO}	Emitter to Base voltage	10	V
V_{CEO}	Collector to Emitter voltage	50	V
V_{IN}	Input voltage	40	V
I_C	Collector current	100	mA
I_{CM}	Peak Collector current	200	mA
P_T	Total dissipation	200	mW
T_j	Junction temperature	+150	$^\circ\text{C}$
T_{stg}	Storage temperature	-55~+150	$^\circ\text{C}$

MARKING

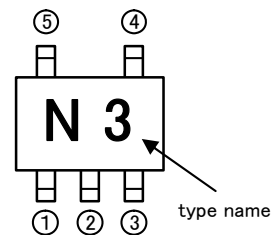

ELECTRICAL CHARACTERISTICS($T_a=25^\circ\text{C}$)(RTr1, RTr2 COMMON)

SYMBOL	PARAMETER	TEST CONDITIONS	LIMITS			UNIT
			MIN	TYP	MAX	
$V_{(BR)CEO}$	Collector to Emitter breakdown voltage	$I_C=100\mu\text{A}$, $R_{BE}=\infty$	50	-	-	V
I_{CBO}	Collector cut off current	$V_{CB}=50\text{V}$, $I_E=0$	-	-	0.1	μA
I_{EBO}	Emitter cut off current	$V_{EB}=5\text{V}$, $I_C=0$	41	53	76	μA
h_{FE}	DC forward current gain	$V_{CE}=5\text{V}$, $I_C=5\text{mA}$	50	-	-	-
$V_{CE(sat)}$	Collector to Emitter saturation voltage	$I_C=10\text{mA}$, $I_B=0.5\text{mA}$	-	-	0.3	V
$V_{I(ON)}$	Input on voltage	$V_{CE}=0.2\text{V}$, $I_C=5\text{mA}$	-	2.2	5.0	V
$V_{I(OFF)}$	Input off voltage	$V_{CE}=5\text{V}$, $I_C=100\mu\text{A}$	0.8	1.1	-	V
R_1	Input resistor	-	33	47	61	$k\Omega$
R_2/R_1	Resistor ratio	-	0.9	1.0	1.1	-
f_T	Gain band width product	$V_{CE}=6\text{V}$, $I_E=-10\text{mA}$	-	200	-	MHz

RT2N05M

Composite Transistor With Resistor
For Switching Application
Silicon NPN Epitaxial Type

TYPICAL CHARACTERISTICS

(RT_{r1}, RT_{r2} COMMON)

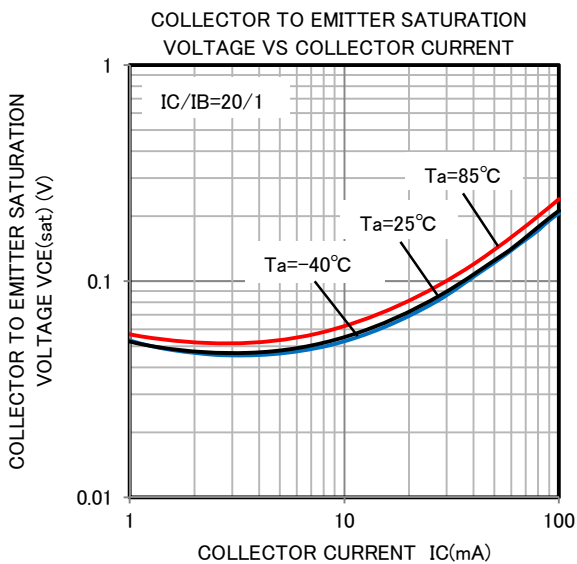
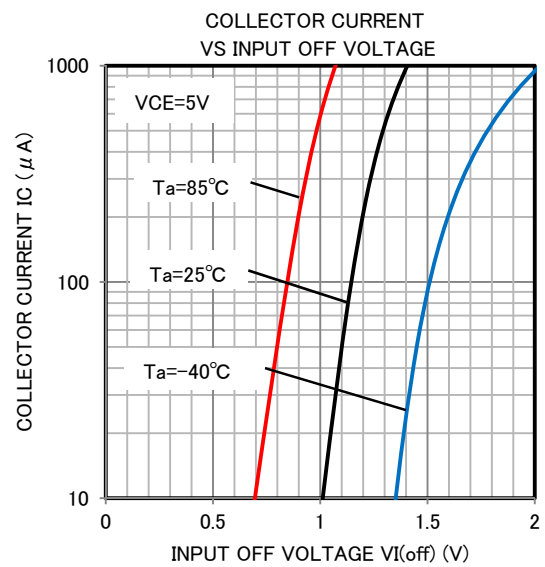
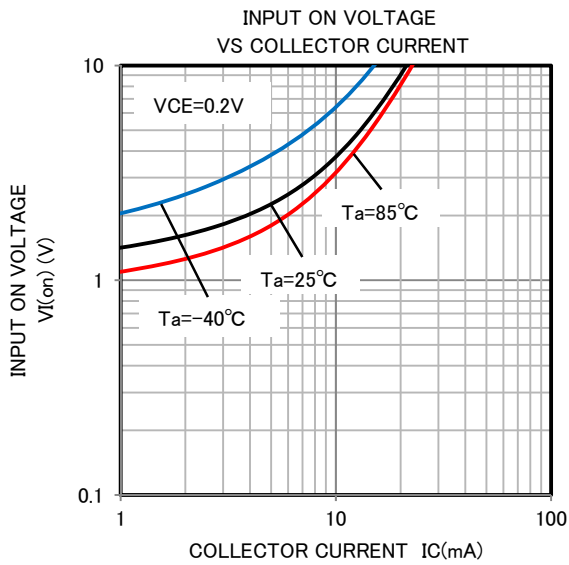
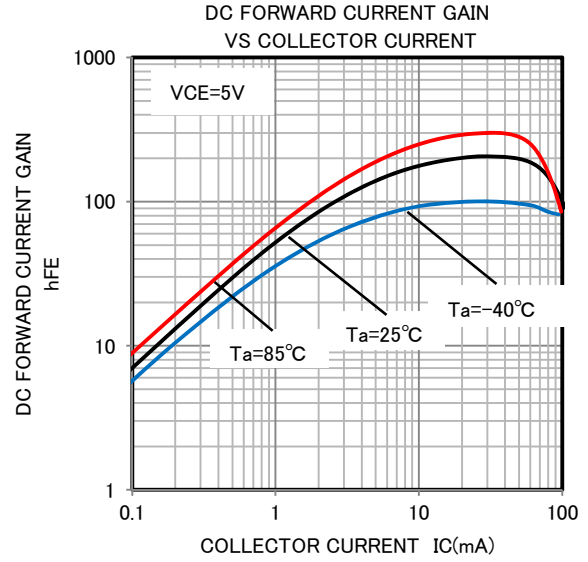
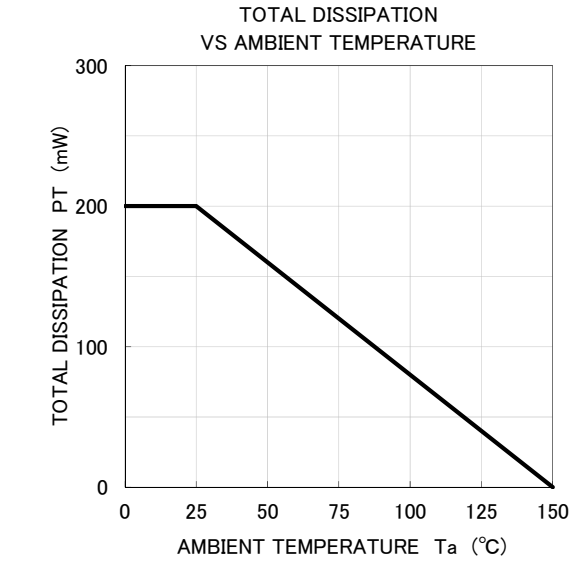



Keep safety first in your circuit designs!

·ISAHAYA Electronics Corporation puts the maximum effort into making semiconductor products better and more reliable, but there is always the possibility that trouble may occur with them. Trouble with semiconductors may lead to personal injury, fire or property damage. Remember to give due consideration to safety when making your circuit designs, with appropriate measures such as (1) placement of substitutive, auxiliary, (2) use of non-flammable material or (3) prevention against any malfunction or mishap.

Notes regarding these materials

- These materials are intended as a reference to our customers in the selection of the ISAHAYA products best suited to the customer's application; they don't convey any license under any intellectual property rights, or any other rights, belonging ISAHAYA or third party.
- ISAHAYA Electronics Corporation assumes no responsibility for any damage, or infringement of any third party's rights, originating in the use of any product data, diagrams, charts or circuit application examples contained in these materials.
- All information contained in these materials, including product data, diagrams and charts, represent information on products at the time of publication of these materials, and are subject to change by ISAHAYA Electronics Corporation without notice due to product improvements or other reasons. It is therefore recommended that customers contact ISAHAYA Electronics Corporation or an authorized ISAHAYA products distributor for the latest product information before purchasing product listed herein.
- ISAHAYA Electronics Corporation products are not designed or manufactured for use in a device or system that is used under circumstances in which human life is potentially at stake. Please contact ISAHAYA Electronics Corporation or an authorized ISAHAYA products distributor when considering the use of a product contained herein for any specific purposes, such as apparatus or systems for transportation, vehicular, medical, aerospace, nuclear, or undersea repeater use.
- The prior written approval of ISAHAYA Electronics Corporation is necessary to reprint or reproduce in whole or in part these materials.
- If these products or technologies are subject to the Japanese export control restrictions, they must be exported under a license from the Japanese government and cannot be imported into a country other than the approved destination. Any diversion or re-export contrary to the export control laws and regulations of Japan and/or the country of destination is prohibited.
- Please contact ISAHAYA Electronics Corporation or authorized ISAHAYA products distributor for further details on these materials or the products contained therein.