

# INKE211AC1-T150

Built-in Zener Diode  
MOS field-effect transistor  
Silicon N-channel

AEC-Q101 Compliance

## DESCRIPTION

INKE211AC1 is a silicon N-channel MOS transistors with built-in Zener diode between drain and source, and small package (SC-59).

## FEATURE

- Low on Resistance.  
 $R_{DS(ON)}=250\text{m}\Omega$  (TYP) @ $I_D=500\text{mA}$ ,  $V_{GS}=4.5\text{V}$   
 $R_{DS(ON)}=200\text{m}\Omega$  (TYP) @ $I_D=500\text{mA}$ ,  $V_{GS}=10\text{V}$
- High speed switching.
- Drive voltage 4V
- Built-in Zener diode between drain and source.
- Large avalanche resistance.
- Small package for High-density packaging.

## APPLICATION

Motor drive, High-speed switching  
Analog switching, and others.

## OUTLINE DRAWING

UNIT: mm

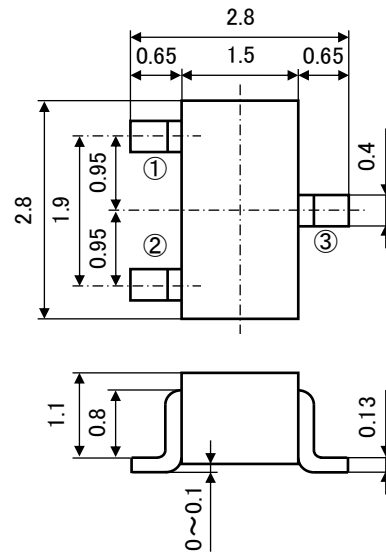

TERMINAL CONNECTOR

- ①: GATE
- ②: SOURCE
- ③: DRAIN

JEITA: SC-59

JEDEC: Similar to TO-236

## MAXIMUM RATINGS ( $T_a=25^\circ\text{C}$ )

Symbol	Parameter	Rating	Unit
$V_{GS}$	Gate-Source Voltage	$\pm 20$	V
$I_D$	Drain Current(DC)	1	A
$I_{DP}$	Drain Current(Pulse) ※1	2	A
PD	Total Power Dissipation	200	mW
		550 (※2)	mW
$I_{AV}$	Avalanche Current ※3,※4	1.0	A
EAV	Avalanche Energy ※3,※4	0.06	mJ
$T_{ch}$	Channel Temperature	+150	$^\circ\text{C}$
$T_{stg}$	Storage Temperature	-55~+150	$^\circ\text{C}$

※1 :  $P_w \leq 1\text{ms}$ , Duty  $\leq 1\%$

※2 : Package mounted on glass-epoxy substrate (20mm × 20mm × 1mm, Cu pad 100mm<sup>2</sup>)

※3 : Consecutive pulses  $P_w \leq 20\ \mu\text{s}$ , Duty  $\leq 0.2\%$

※4 :  $L=100\ \mu\text{H}$

## EQUIVALENT CIRCUIT

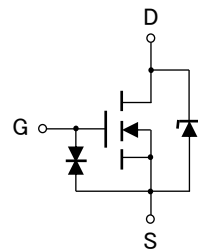

## MARKING

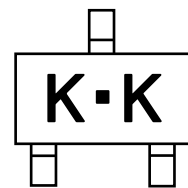

# INKE211AC1-T150

Built-in Zener Diode  
MOS field-effect transistor  
Silicon N-channel

## 【MOSFET】 ELECTRICAL CHARACTERISTICS (Ta=25°C)

Symbol	Parameter	Test Condition	Limit			Unit
			MIN.	TYP.	MAX.	
V(BR)DSS	Drain-Source Breakdown Voltage	Id=100μA, VGS=0V	40	-	60	V
IGSS	Gate-Source Leak current	VGS=±20V, VDS=0V	-	-	±10	μA
IDSS	Zero Gate Voltage Drain Current	VDS=40V, VGS=0V	-	-	1	μA
Vth	Gate Threshold Voltage	Id=250μA, VDS=VGS	1.0	-	2.0	V
Yfs	Forward Transfer Admittance	VDS=10V, ID=500mA	-	1.5	-	S
RDS(ON)	Static Drain-Source On-State Resistance	Id=500mA, VGS=4.5V	-	250	-	mΩ
		Id=500mA, VGS=10V	-	200	-	
Ciss	Input Capacitance	VDS=5V, VGS=0V, f=1MHz	-	170	-	pF
Coss	Output Capacitance		-	40	-	
ton	Switching Time	VDD=5V, ID=250mA VGS=0~5V	-	170	-	ns
toff			-	85	-	

## 【Zener Diode】 ELECTRICAL CHARACTERISTICS (Ta=25°C)

Zener Voltage Vz(V)			Reverse current IR(μA)	
MIN	MAX	Iz(mA)	MAX	VR(V)
40	60	0.1	1.0	40

### Avalanche current test condition

Ta=25°C  
RG=25Ω  
VDD=20V  
VGS=10→0V

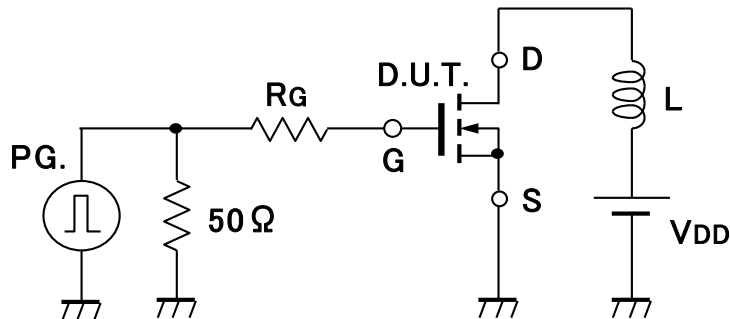

### Switching time test condition

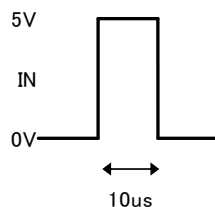
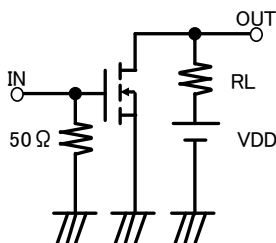

Duty ≤ 1%  
Input: tr, tf < 10ns  
VDD = 5V  
Common source  
Ta = 25°C

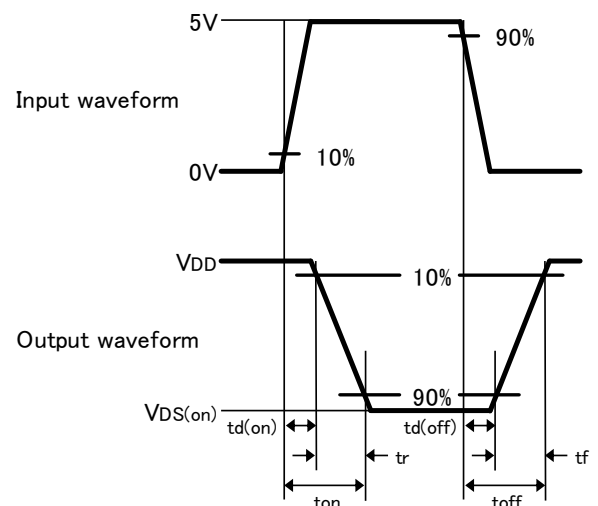

# INKE211AC1-T150

Built-in Zener Diode  
MOS field-effect transistor  
Silicon N-channel

## TYPICAL CHARACTERISTICS

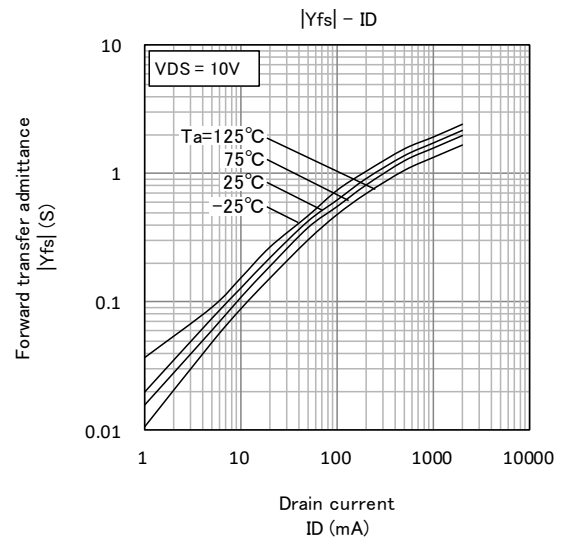
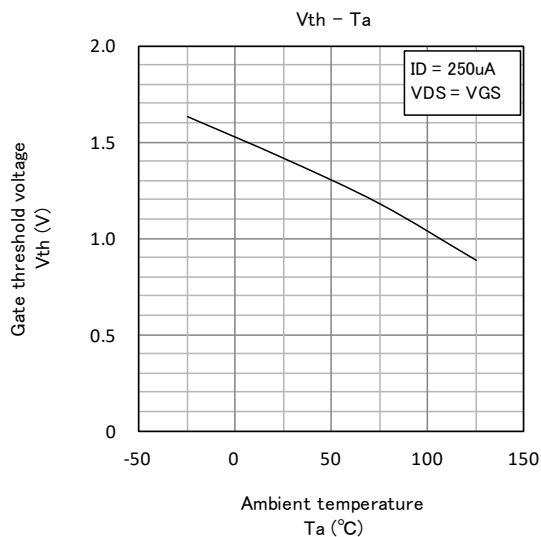
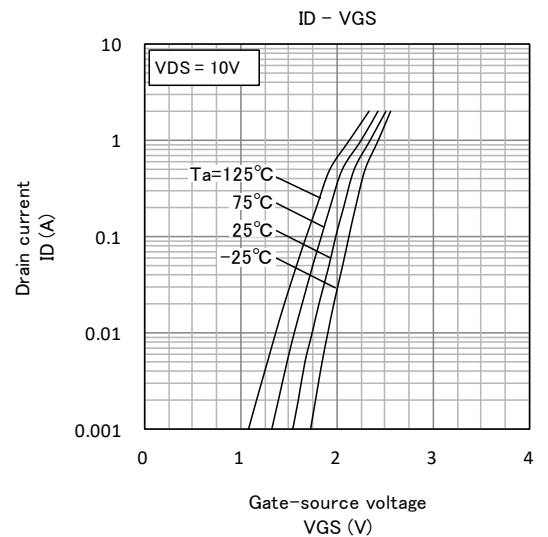
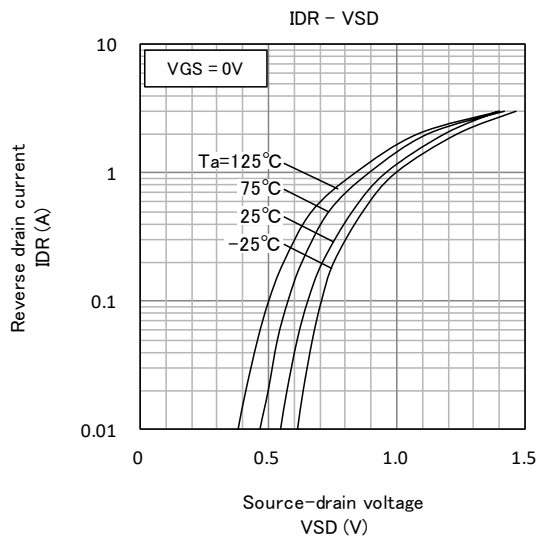
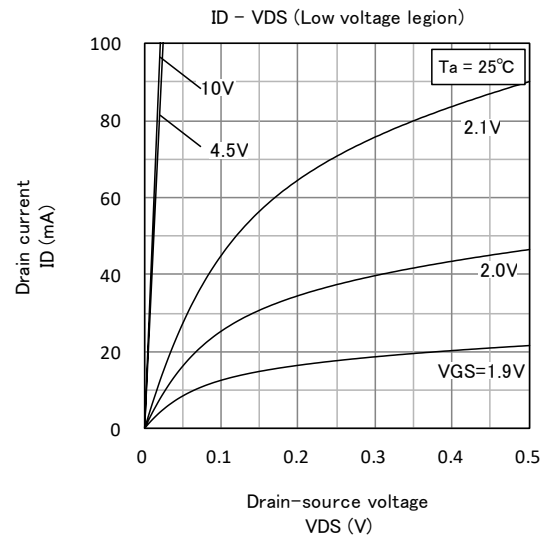
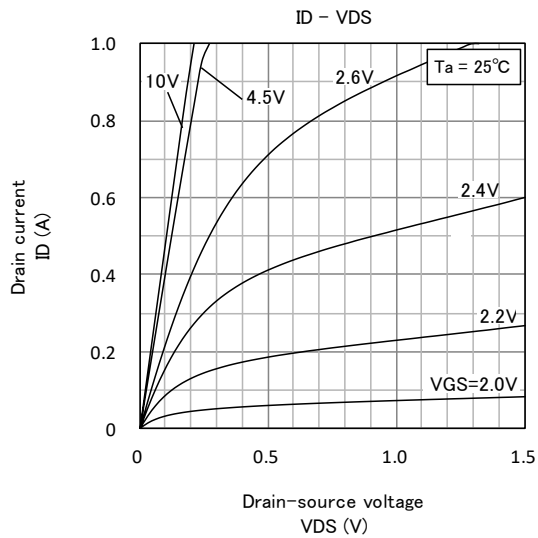

# INKE211AC1-T150

Built-in Zener Diode  
MOS field-effect transistor  
Silicon N-channel

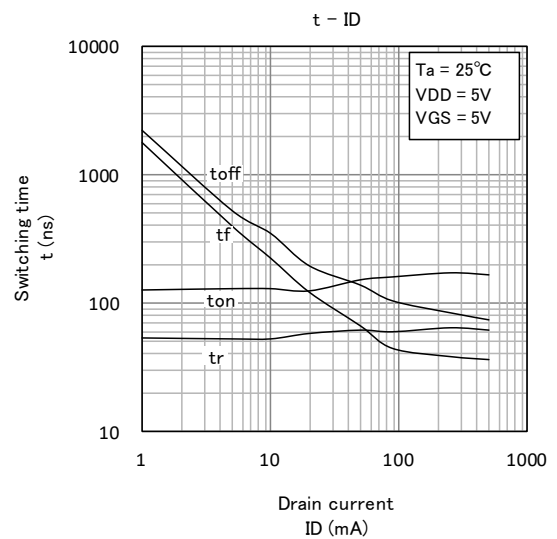
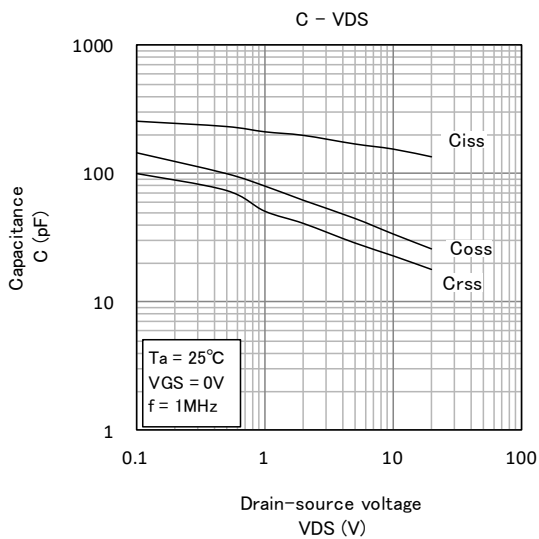
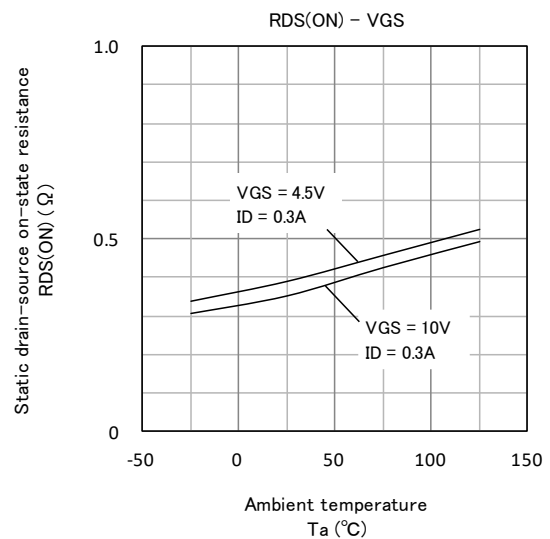
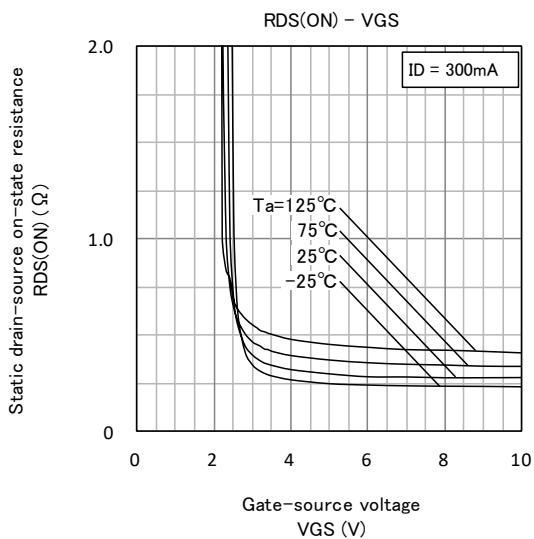
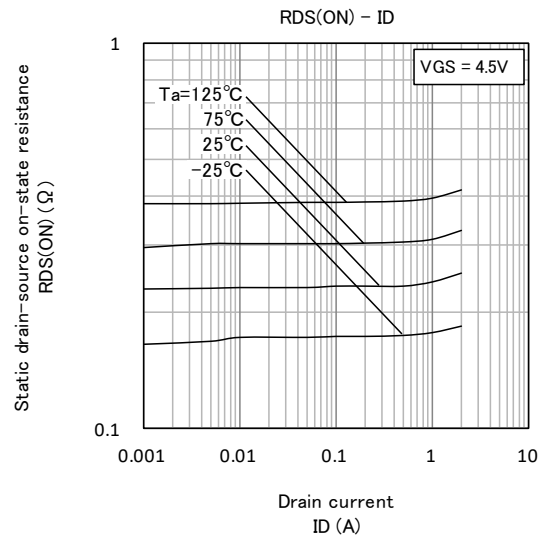
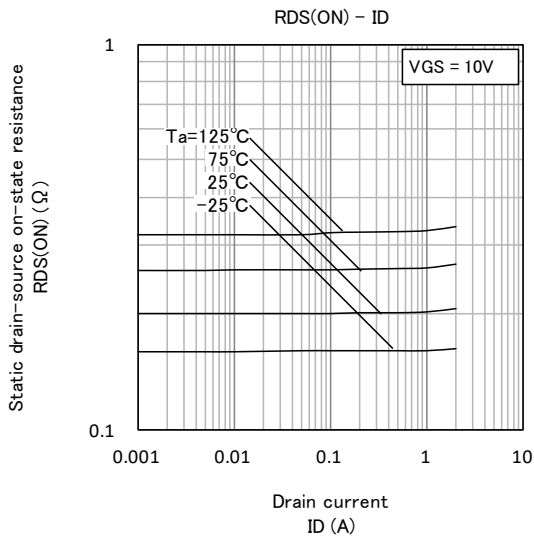

# INKE211AC1-T150

Built-in Zener Diode  
MOS field-effect transistor  
Silicon N-channel

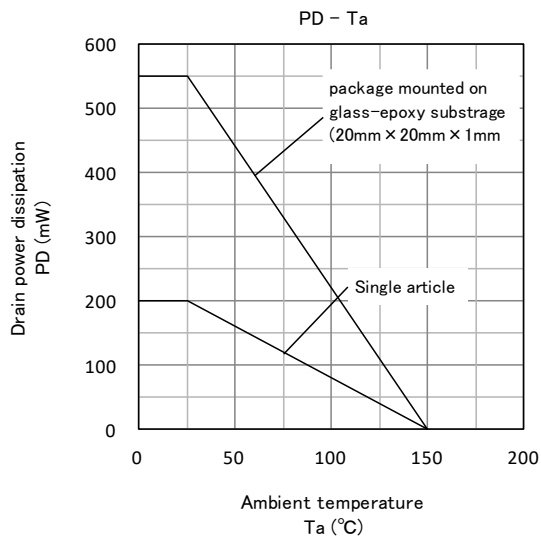
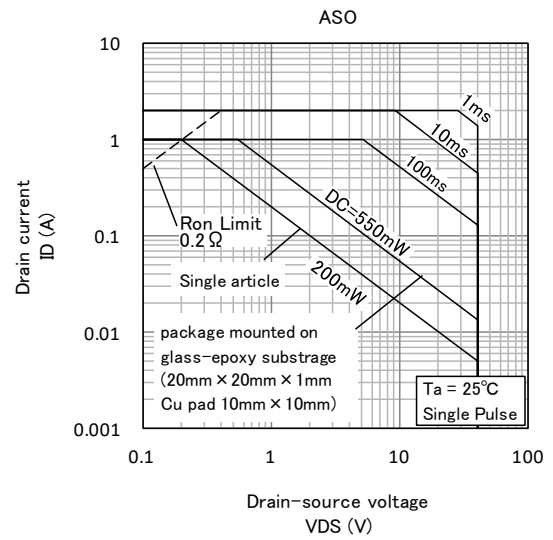
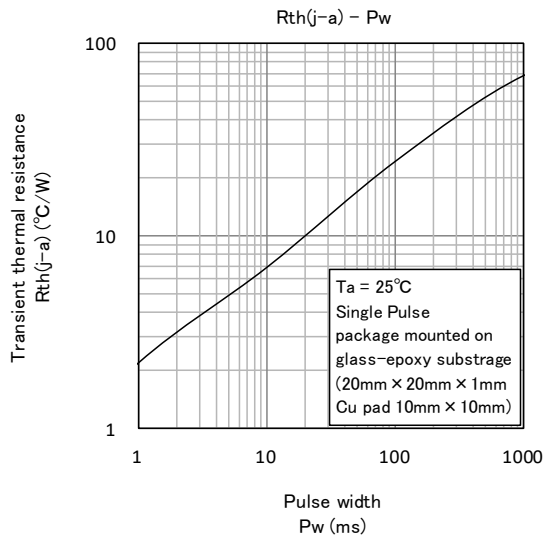

---

**Keep safety first in your circuit designs!**

·ISAHAYA Electronics Corporation puts the maximum effort into making semiconductor products better and more reliable, but there is always the possibility that trouble may occur with them. Trouble with semiconductors may lead to personal injury, fire or property damage. Remember to give due consideration to safety when making your circuit designs, with appropriate measures such as (1) placement of substitutive, auxiliary, (2) use of non-flammable material or (3) prevention against any malfunction or mishap.

**Notes regarding these materials**

- These materials are intended as a reference to our customers in the selection of the ISAHAYA products best suited to the customer's application; they don't convey any license under any intellectual property rights, or any other rights, belonging ISAHAYA or third party.
- ISAHAYA Electronics Corporation assumes no responsibility for any damage, or infringement of any third party's rights, originating in the use of any product data, diagrams, charts or circuit application examples contained in these materials.
- All information contained in these materials, including product data, diagrams and charts, represent information on products at the time of publication of these materials, and are subject to change by ISAHAYA Electronics Corporation without notice due to product improvements or other reasons. It is therefore recommended that customers contact ISAHAYA Electronics Corporation or an authorized ISAHAYA products distributor for the latest product information before purchasing product listed herein.
- ISAHAYA Electronics Corporation products are not designed or manufactured for use in a device or system that is used under circumstances in which human life is potentially at stake. Please contact ISAHAYA Electronics Corporation or an authorized ISAHAYA products distributor when considering the use of a product contained herein for any specific purposes, such as apparatus or systems for transportation, vehicular, medical, aerospace, nuclear, or undersea repeater use.
- The prior written approval of ISAHAYA Electronics Corporation is necessary to reprint or reproduce in whole or in part these materials.
- If these products or technologies are subject to the Japanese export control restrictions, they must be exported under a license from the Japanese government and cannot be imported into a country other than the approved destination. Any diversion or re-export contrary to the export control laws and regulations of Japan and/or the country of destination is prohibited.
- Please contact ISAHAYA Electronics Corporation or authorized ISAHAYA products distributor for further details on these materials or the products contained therein.